



## AIR-OPERATED PISTON PUMPS

CSF INOX's PNEUMATIC PUMPS come in various version, in terms of both construction materials and the various uses for which they are designed. They have been conceived to meet an extremely wide range of needs for handling highly viscous products. Designed to transfer, deliver and transport liquids, also with an adjustable flow rate when necessary. Thanks to the air motor they are particularly indicated for potentially explosive atmospheres (ATEX certified on request). They have gaskets and pumping elements selected from a wide range of materials and profiles designed and tested for numerous applications.



### PA Hygienic series

Wetted parts in AISI 316 stainless steel in both, short or long versions. Pump components are assembled with quick-release clamps for quick and easy strip cleaning.

### PAR Light duty industrial series

Wetted parts stainless steel in AISI 316. Pump components are screwed together. Very cost effective. Connections: GAS thread/BSP.

### Applications

Creams, puddings, sweet pastry fillings, ice-cream, eggs, zabaione, melted cheese, jam, yoghurt, candied fruit in syrup (mostarda), minestrone, mustard, polenta, mayonnaise, melted chocolate, oils; syrups, juices, wines, spirits, glucose, concentrates, essences, flavours; extracts, essences, solutions, soaps, shampoo, shower gel, fragrances, toothpaste, shaving cream, beauty creams; acids, bases, salt solutions/dispersions, solvents, liquefied gases, oils, paints, temperas, fillers, varnishes, resins, inks, putty, glue.

### TECHNICAL DATA

Flow rates up to 80 l/min.  
Pressure from 0 to 150 bar.

#### Elastomers (FDA Regulation (EC) No. 1935/2004):

NBR  
FPM - FKM  
P.T.F.E.  
Algoflon

#### Connections:

DIN - SMS - IDF - BS / RJT - DS - CLAMP and  
EN1092-1 PN16 and GAS thread/BSP connections.



PAR  
short pump

PA-AM  
short pump

PA-AM  
long pump



## OVERALL DIMENSIONS AND PERFORMANCE - PA FOOD SERIES

TYPE	Z	A		B	ØC	Delivery port	Suction port			Max. air consumption: in l/min. at supply pressure
	Ø Air inlet	Height between suction and delivery ports				DNm	Long	Short		
		Long	Short				D	D	DNa	
PA 20A - 45	1/4" Gas	494	-	295	55	1/4" Gas F	Ø 27	-	-	17
PA 30A - 45	1/4" Gas	1097	472	311	55	3/8" Gas F	Ø 34	Ø 39	1/2" Gas F	17
PA 50AM - 63	1/4" Gas	1194	302	441	68	DN32F/DIN 11851	Ø 51	-	DN32F/DIN 11851	42
PA 50AM - 80	1/4" Gas	1194	302	488	105	DN32F/DIN 11851	Ø 51	-	DN32F/DIN 11851	90
PA 50AM - 200	1/2" Gas	1194	302	639	228	DN32F/DIN 11851	Ø 51	-	DN32F/DIN 11851	104
PA 50AM - 230	1/2" Gas	1194	302	755	228	DN32F/DIN 11851	Ø 51	-	DN32F/DIN 11851	250
PA 65AM - 80	1/4" Gas	1134	400	503	105	DN40F/DIN 11851	Ø 84	-	DN40F/DIN 11851	90
PA 65AM - 200	1/2" Gas	1134	400	648	228	DN40F/DIN 11851	Ø 84	-	DN40F/DIN 11851	104
PA 65AM - 230	1/2" Gas	1134	400	766	228	DN40F/DIN 11851	Ø 84	-	DN40F/DIN 11851	250
PA 65AM - 250	1/2" Gas	1134	400	647	249	DN40F/DIN 11851	Ø 84	-	DN40F/DIN 11851	200
PA 65AM - 255	1/2" Gas	1134	400	764	249	DN40F/DIN 11851	Ø 84	-	DN40F/DIN 11851	330
PA 80AM - 200	1/2" Gas	1131	397	705	228	DN50F/DIN 11851	Ø 89	-	DN50F/DIN 11851	104
PA 80AM - 230	1/2" Gas	1131	397	770	228	DN50F/DIN 11851	Ø 89	-	DN50F/DIN 11851	250
PA 80AM - 250	1/2" Gas	1131	397	704	249	DN50F/DIN 11851	Ø 89	-	DN50F/DIN 11851	200
PA 80AM - 255	1/2" Gas	1131	397	768	249	DN50F/DIN 11851	Ø 89	-	DN50F/DIN 11851	330
PA 80AM - 310	3/4" Gas	1131	397	783	280	DN50F/DIN 11851	Ø 89	-	DN50F/DIN 11851	620
PA100AM - 200	1/2" Gas	900	470	697	228	DN50F/DIN 11851	Ø 120	-	DN65F/DIN 11851	104
PA 100AM - 230	1/2" Gas	900	470	762	228	DN50F/DIN 11851	Ø 120	-	DN65F/DIN 11851	250
PA 100AM - 255	1/2" Gas	900	470	760	249	DN50F/DIN 11851	Ø 120	-	DN65F/DIN 11851	330
PA 100AM - 310	3/4" Gas	900	470	760	280	DN50F/DIN 11851	Ø 120	-	DN65F/DIN 11851	620
PA 140A - 230	1/2" Gas	1243	341	794	228	DN50F/DIN 11851	Ø 140	-	DN80F/DIN 11851	250
PA 140A - 255	1/2" Gas	1243	341	792	249	DN50F/DIN 11851	Ø 140	-	DN80F/DIN 11851	330
PA 140A - 310	3/4" Gas	1243	341	807	280	DN50F/DIN 11851	Ø 140	-	DN80F/DIN 11851	620

PA 20A - L  
PA 30A - L

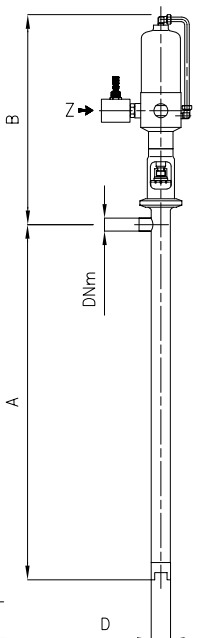

PA 50AM - L  
PA 65AM - L  
PA 80AM - L  
PA100AM - L

PA 50AM - C  
PA 65AM - C  
PA 80AM - C  
PA100AM - C

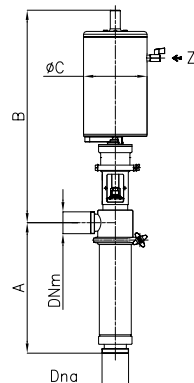

PA 140A - L  
with bottom  
suction  
valve

PA 140A - L  
with pick-up  
tube

PA 140A - C

PA 30A - C

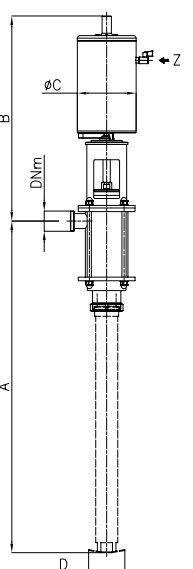
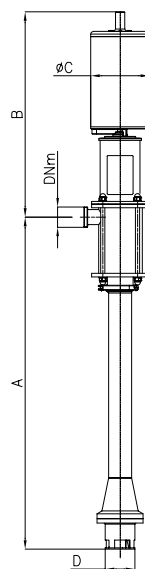
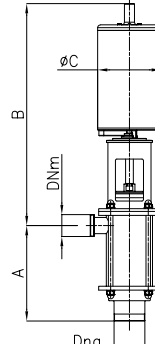
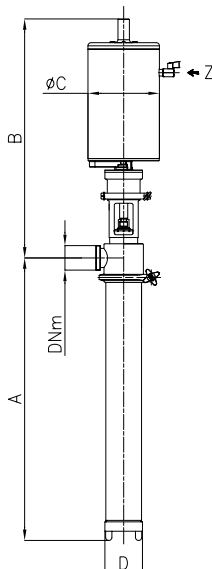
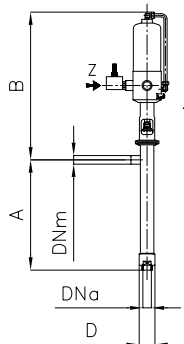

PUMPS	Pressure ratio	Recomm. max. cycles per minute	Max. flow rate l/min for viscosity of 1000 cP
PA 20A-45	25 : 1	150	1
* PA 30A-45	5 : 1	150	2
* PA 50AM-63	3,4 : 1	120	7,6
* PA 50AM-80	5,3 : 1	90	10
* PA 50AM-200	8,4 : 1	60	7,5
PA 50AM-230	14,6 : 1	50	10,6
* PA 65AM-80	1,6 : 1	80	20
* PA 65AM-200	2,5 : 1	60	17
* PA 65AM-230	4 : 1	50	24
PA 65AM-250	6 : 1	50	14

PUMPS	Pressure ratio	Recomm. max. cycles per minute	Max. flow rate l/min for viscosity of 1000 cP
* PA 80AM-200	2 : 1	60	24
* PA 80AM-230	3,3 : 1	50	33
* PA 80AM-250	4,5 : 1	50	20
PA 80AM-310	9 : 1	50	32
* PA 100AM-200	1 : 1	60	37
* PA 100AM-230	1,8 : 1	50	52
* PA 100AM-255	2,5 : 1	50	52
* PA 100AM-310	5 : 1	50	50
* PA140A-230	1,6 : 1	50	100
* PA140A-255	2,2 : 1	50	100
* PA140A-310	4 : 1	50	95

\*Available with ATEX 2G and 3G certification

## OVERALL DIMENSIONS AND PERFORMANCE - PAR SERIES

DIMENSIONS									
TYPE	Z	A		B	Delivery port	Suction port		Max. air consumption in l/min at supply pressure	
	Ø Air inlet	Height between suction and delivery ports		DNm	DNm	Long	Short		
		Long	Short			D	DNa		
PAR 30 - 50	1/4" Gas	1041	211	373	3/4" Gas F	Ø 34	1/2" Gas F	25	
PAR 40 - 50	1/4" Gas	1027	259	373	3/4" Gas F	Ø 42	3/4" Gas F	25	
PAR 50 - 50	1/4" Gas	1005	265	368	3/4" Gas F	Ø 54	3/4" Gas F	25	
PAR 50 - 65	3/8" Gas	1062	339	469	1 1/2" Gas F	Ø 54	3/4" Gas F	45	

PUMPS	Pressure ratio	Recomm. max. cycles per minute	Max. flow rate l/min for viscosity of 1000 cP
PAR 30-50	4 : 1	180	7,5
PAR 40-50	2 : 1	180	12
PAR 50-50	1 : 1	180	25
PAR 50-65	2 : 1	160	25

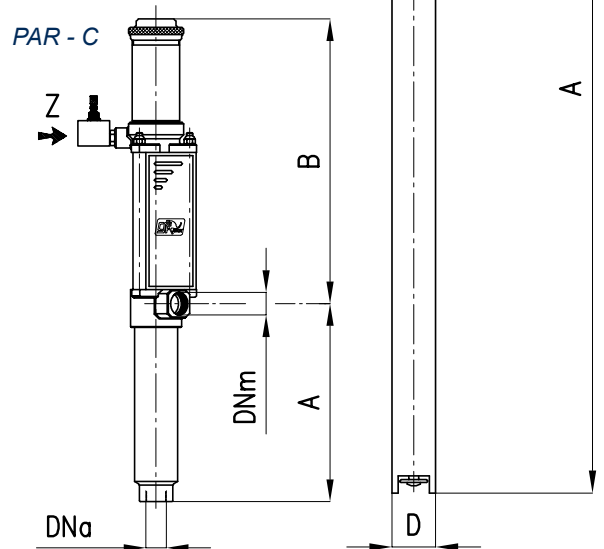
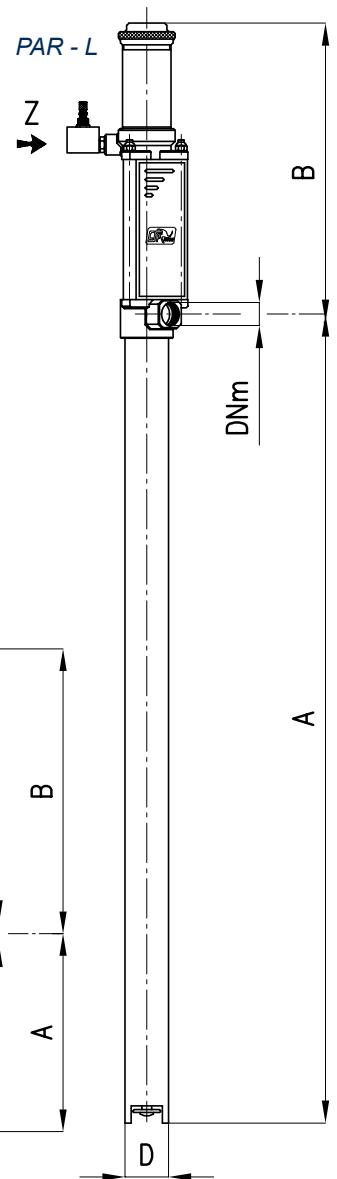

## VARIOUS OPTIONS

(for drum unloading station options consult the DCATLSPGB brochure)

Air-operated piston pump with mobile lift.  
Manual sliding lift model with counterweight assistance.



Air-operated piston pump with mobile lift with  
pneumatic cylinder and control panel.



Trolley with rotating support to facilitate  
pump disassembly and maintenance  
(available only for short versions).



Short air-operated piston pump  
on tripod with wheels.



Short air-operated piston pump with  
scraper plate to empty barrels or  
cylindrical tanks. Excellent for high  
viscosity products.



## ACCESSORIES



2" threaded clamp for drums

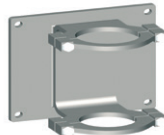

Wall brackets for holding  
and fixing pumps



Outlet Pulsation Dampener



C.S.F. Inox S.p.A. Strada per Bibbiano, 7 - 42027 Montecchio E. (RE) - ITALY EU

Ph +39.0522.869911 r.a. - Fx +39.0522.865454 - italia@csf.it - www.csf.it

Export Department • Commercial Étranger • Comercial Extranjero

Ph +39.0522.869922 - Fx +39.0522.869841 - export@csf.it - www.csf.it



All the instructions, data and representations (in whatever way executed) listed in this publication are indicative and do not bind. C.S.F. does not stand surety or undertake any obligation for the utilisation of this document and for the information contained. In particular, it does not guarantee against omissions or errors of the data and drawings here indicated. Notice that the technical specifications, information and representations in this document are merely indicative and approximate. C.S.F. INOX reserves the right at any moment and without notice to modify the data, drawings and information indicated in this document.